

XL surface mounted

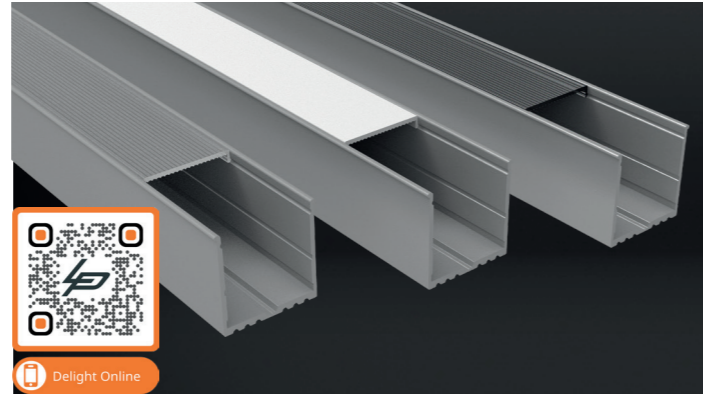

Product name	Alupro LED profile XL surface mounted
Color	Aluminium
Length	2m
Width	35mm
Height	34,8mm
Max. LED strip power	28,8 W/m

PROFILES AND ENDCAPS

Aluminium	White	Black	
2.01.0670	-	-	Alupro LED profile XL surface mounted 2m
2.01.0674	-	-	Alupro LED profile XL surface mounted endcap closed for profile 2m
2.01.0673	-	-	Alupro LED profile XL surface mounted endcap open for profile 2m

COVERS AND MOUNTING CLIPS

Article No.	
2.01.0666	Alupro LED profile XL surface mounted cover PMMA opal 2m
2.01.0667	Alupro LED profile XL surface mounted cover PMMA matt 2m
2.01.0668	Alupro LED profile XL surface mounted cover PMMA transparent 2m

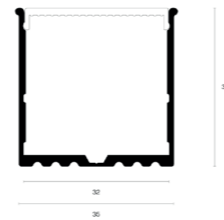

XLC Plus



Product name	Alupro LED profile XLC Plus
Color	Aluminium
Length	2,5m
Width	30mm
Height	32mm
Max. LED strip power	24 W/m

PROFILES AND ENDCAPS

Aluminium	White	Black	
2.01.1022	-	-	Alupro LED profile XLC Plus + cover PC opal surface mounted 2,5m
2.01.1023	-	-	Alupro LED profile XLC Plus endcap closed (2 pieces) for profile surface mounted

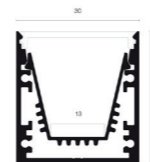

XLS Plus

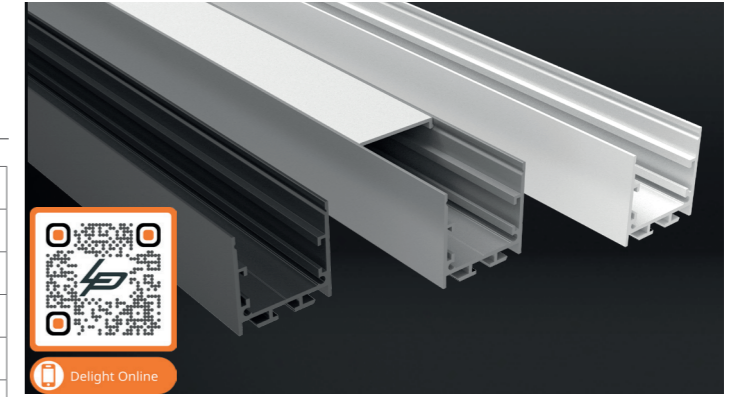

Product name	Alupro LED profile XLS Plus
Color	Aluminium, white and black
Length	2m
Width	35mm
Height	35mm
Max. LED strip power	28,8 W/m

PROFILES AND ENDCAPS

Aluminium	White	Black	
2.01.1035	2.01.1334	2.01.1335	Alupro LED profile XLS Plus + cover PC opal surface mounted 2m
2.01.1036	2.01.1336	2.01.1337	Alupro LED profile XLS Plus endcap aluminium closed (2 pieces) for profile surface mounted

COVERS AND MOUNTING CLIPS

Article No.	
2.01.1033	Alupro LED profile XLR/XLS Plus connection clip (2 pieces)
2.01.1037	Alupro LED profile XLS Plus mounting clip for profile surface mounted 2m and pendant extension rod
2.01.1041	Suspension set for Alupro XLH,XLM,XLS,XLW LED Plus

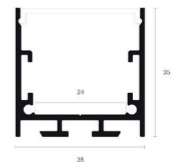

XLM Plus

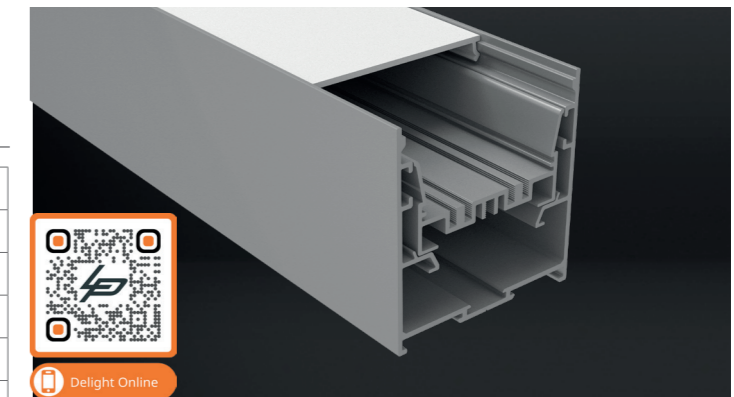

Product name	Alupro LED profile XLM Plus
Color	Aluminium
Length	2,5m
Width	75mm
Height	87mm
Max. LED strip power	42 W/m

PROFILES AND ENDCAPS

Aluminium	White	Black	
2.01.1028	-	-	Alupro LED profile XLM Plus + cover PC opal surface mounted 2,5m incl. fall protection
2.01.1029	-	-	Alupro LED profile XLM Plus endcapdie-cast closed (2 pieces) for profile surface mounted

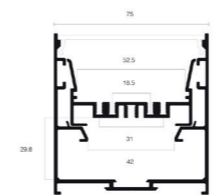

COVERS AND MOUNTING CLIPS

Article No.	
2.01.1030	Alupro LED profile XLM Plus mounting clip for profile surface mounted 2,5m and pendant extension rod
2.01.1041	Suspension set for Alupro Plus XLH,XLM,XLS,XLW LED